

ToMo



ToMo

POS SCALE

WEIGH TOGETHER. MOVE TOGETHER.

SHANGHAI TERAOKA ELECTRONIC Co., Ltd.

1 Ting Lin Industry Developmental Zone, Jin Shan County,
Shanghai 201505, China
www.digisystem.com/



Form, function, and reliability— all in one little scale.

ToMo is a compact POS scale. Sturdy and lightweight, ToMo is compatible with QR code mobile payments and is designed for connecting with the cloud, making it ideal for open markets and mobile catering configurations. Although small in stature and highly portable, it maintains the full functionality of a POS scale and requires little to no training to operate. The scale complies with fiscal law in major European countries. It also boasts an attractive design and is available in three appealing colors.

Available in 3 colors

Bordeaux Red

Elegant and alluring.



Customer side



Pole type (optional)



Custard Yellow

Friendly and warm.



Earth Gray

Natural and comforting.



Reliable. Powerful. Compact.

ToMo is a scale that you can count on. Lightweight and portable, with all the power of a high-function DIGI scale.

Operator side

10.1-inch TFT LCD Panel with Touch panel
(High-resolution display)

- ▶ 1 x Cash drawer control port
- ▶ 1 x Serial port (RS-232)
- ▶ 2 x USB 3.0
- ▶ 1 x 10/100/1000M Ethernet

Optional:
Wireless LAN Adapter



20.5cm

Battery Life

16 hours
Without using printer

- ▶ High speed print
- ▶ Easy paper installation
- ▶ Maintenance-free

27.4cm

37.4cm

7-inch TFT LCD Panel



Customer side

7-inch
TFT LCD Panel
Adjustable display



Customer side (Pole type)

User-friendly operation

Powered by Max POS

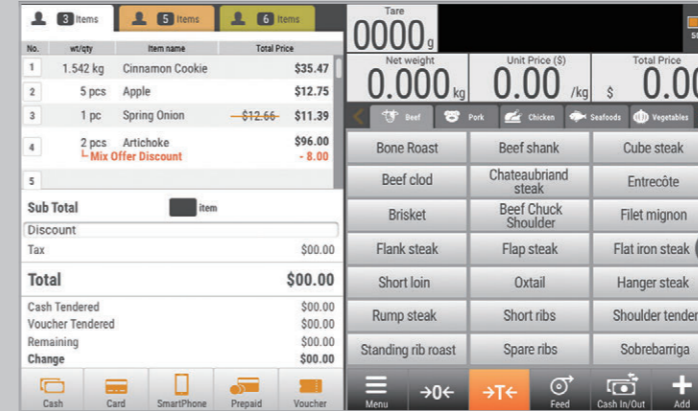

- No training necessary
- Simple one-screen operation
- Clear and attractive typeface
- Intuitive button layout with pictogram icons
- Reduce human error with well-designed interface

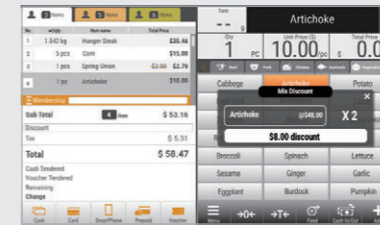
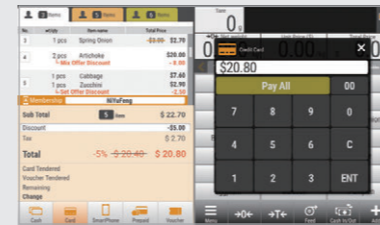

UI utilizes pop-up dialogue boxes, so you can easily view everything on a single screen.

System settings are also simple and easy to use.

Pay with your mobile device.



When finished with a transaction, a QR code with vendor ID and total price will be generated and shown on the customer display. The customer can scan this barcode with a checkout app, confirm the total amount, and pay.



Max POS POS application software



Offers a quick and easy way to process sales.

MaxPOS is a price computing scale software which adds full POS functions to the scale. In addition to scale functions, it has all the standard functions of a POS and runs on winXP or Linux platforms. By keeping track of the merchandise you weigh and scan, it allows you to collect sales information and keep your inventory up-to-date.

Max Chain

Web-based back office HQ system application

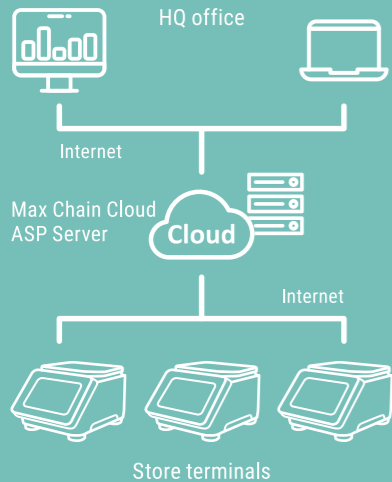

This system provides sales, purchase, and warehouse control, as well as other functions. With Max Chain, you can keep track of your inventory, daily sales, and customer information from any device with an internet connection.

- Purchase management
- Inventory management
- Distribution management
- Store setup
- Store member setup
- Sales analysis
- General setup
- System maintenance

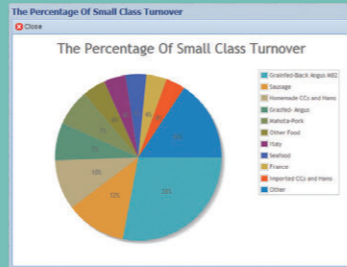

Dimensions

Bench type

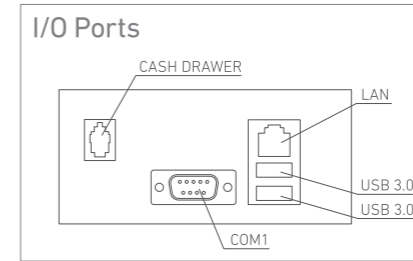
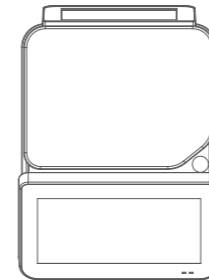
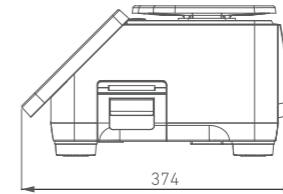
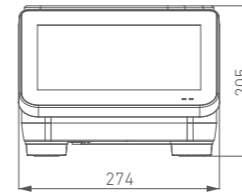

Pole type

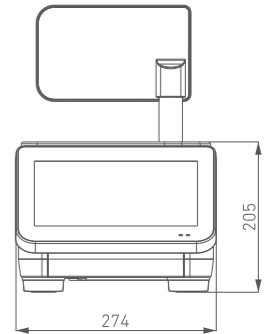
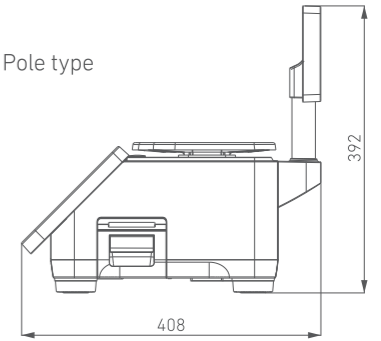

Specification

Model	RM-5900 ToMo		
Capacity	3/6 kg (6/15lb)	6/15kg (15/30lb)	15/30kg (30/60lb)
Interval	1/2g(0.002/0.005lb)	2/5g(0.002/0.005lb)	5/10g(0.002/0.005lb)
Operator Display	10.1" TFT LCD with touch panel		
Customer Display	7" TFT LCD (Bench type, Pole type)		
Paper Width	58mm		
Print Speed	Maximum 75mm/sec		
Standard Interface	1 x Cash drawer control port, 1 x Serial port (RS-232) 2 x USB3.0, 1 x 10/100/1000M Ethernet		
Power Source	AC 110/240V 50/60Hz		
Operating Temperature	-10°C to +40°C		
Humidity	15% to 85% RH with no condensation		
Dimension/WxDxH	Bench type: W274xH205xD374mm Pole type: W274xH392xD408mm		
Net Weight	Bench type: 6.8kg Pole type: 7.1kg		

*Specifications are subject to change without prior notice.



Options

- ▶ **Rechargeable Battery**
14.8V/10,000mAh Li-ion battery
Net Weight 0.75kg
- ▶ **Wireless LAN Adapter**
*802.11b/g
- ▶ **Large Platter**
W350xH70xD260mm

For oversized items.

